

# VNA Master™

## Handheld Vector Network Analyzer + Spectrum Analyzer

MS2024B	MS2025B	
500 kHz to 4 GHz	500 kHz to 6 GHz	Vector Network Analyzer
MS2034B	MS2035B	
500 kHz to 4 GHz	500 kHz to 6 GHz	Vector Network Analyzer
9 kHz to 4 GHz	9 kHz to 6 GHz	Spectrum Analyzer

The Affordable Handheld Vector Network + Spectrum Analyzer for Cable, Antenna, and Signal Analysis Anytime, Anywhere

### Introduction

Anritsu proudly offers the MS202xB/MS203xB VNA Master + Spectrum Analyzer, the industry’s most affordable and compact handheld solution to address cable, antenna, component, and signal analysis needs in the field. All MS202xB/3xB VNA Master models offer benchtop accuracy and high performance S-parameter measurements in portable form. With frequency coverage from 500 kHz up to 4 or 6 GHz in a truly handheld, battery-operated, rugged, multi-function instrument, the VNA Master also provides a field-friendly touchscreen user interface.

MS2034B/35B models include a powerful spectrum analyzer which multiplies user convenience by combining both a VNA and a separate spectrum analyzer into a single measurement powerhouse for the harsh RF and physical environments of field test. Whether it is for spectrum monitoring, broadcast proofing, interference analysis, RF and microwave measurements, regulatory compliance, 3G/4G, Land Mobile Radio, or wireless data network measurements, this VNA/Spectrum Analyzer combination is the ideal instrument for making fast and reliable measurements in the field.



VNA Master™ MS202xB/MS203xB Vector Network Analyzer + Spectrum Analyzer  
 Compact Size: 199 mm x 273 mm x 91 mm (7.8 in x 10.7 in x 3.6 in), Lightweight: 3.5 kg (7.6 lb)

---

**Vector Network Analyzer Performance and Functional Highlights (All Models)**

- Broadband coverage of 500 kHz to 4/6 GHz
- 1-path, 2-port Vector Network Analyzer
- Intuitive Graphical User Interface (GUI) with convenient Touch Screen
- VNA-quality error correction for directivity and source match
- 2-port Transmission Measurements: High/Default/Low Power
- Outstanding calibration stability, minimal drift error
- Calibration Interpolation feature adds flexibility
- User-defined overlays for viewing multiple S-Parameters
- Arbitrary data points up to 4001
- IF Bandwidth selections of 10 Hz to 100 kHz
- 100 dB Transmission Dynamic Range
- 850  $\mu$ s/data point sweep speed
- Greater than 3 hour battery life
- USB and (Optional) Ethernet for data transfer and instrument control
- User-selectable menu options: Choose either VNA or Field Mode for simplified Cable & Antenna analysis
- Field upgradable firmware
- Internal Flash Memory: 2 GB — Store more than 4000 traces and setups in memory
- Portable: 3.5 kg (7.6 lb)
- Full Speed USB Memory support
- Automate repetitive tasks via optional Ethernet and USB
- High resolution daylight-viewable TFT color display
- "Glove Friendly" Resistive Touchscreen Display
- Distance Domain (Standard with firmware V1.20 and above)
- Internal Bias Tee Option
- Vector Voltmeter Option, ideal for cable phase matching
- High Accuracy Power Meter Option
- GPS Receiver Option
- Polar Format Impedance Display
- Complies with MIL-PRF-28800F Class 2.
- Certified for use in Explosive Atmosphere per MIL-PRF-28800F and MIL-STD-810G

---

**Spectrum Analyzer Performance and Functional Highlights (MS203xB Models Only)**

- Measure: Occupied Bandwidth, Channel Power, ACPR, C/I
- Interference Analyzer: Spectrogram, Signal Strength, RSSI, Signal ID
- Dynamic Range: > 95 dB in 10 Hz RBW
- DANL: -162 dBm in 1 Hz RBW (normalized)
- Phase Noise: -100 dBc/Hz max @ 10 kHz offset at 1 GHz
- Frequency Accuracy: <  $\pm$  50 ppb 3 minutes after GPS lock
- Traces: Normal, Max Hold, Min Hold, Average, # of Averages
- Detectors: Peak, Negative, Sample, Quasi-peak, and RMS
- Markers: 6, each with a Delta Marker, or 1 Reference with 6 Deltas
- Trace Save-on-Event: crossing limit line or sweep complete
- Limit Lines: up to 41 segments with one-button envelope creation
- AM/FM/SSB Audio-only Demodulation
- Optional AM/FM/PM Demodulation Analyzer
- Store thousands of traces internally
- Channel Scanner Option
- GPS tagging of stored traces
- Internal Preamplifier standard
- High Accuracy Power Meter Option
- Coverage Mapping Option

<b>Description</b>	<b>Page</b>
Vector Network Analyzer Performance and Functional Highlights (All Models) . . . . .	2
Spectrum Analyzer Performance and Functional Highlights (MS203xB Models Only) . . .	2
Definitions . . . . .	3
VNA Performance Specifications . . . . .	4
VNA Functional Specifications . . . . .	5
Corrected System Performance and Uncertainties — High Port Power, N-Type . . . . .	6
Corrected System Performance and Uncertainties — High Port Power, K-Type . . . . .	7
Spectrum Analyzer Performance Specifications . . . . .	8
Spectrum Analyzer Functional Specifications. . . . .	10
Bias Tee (Option 10) . . . . .	11
Vector Voltmeter (Option 15) . . . . .	11
High Accuracy Power Meter (Option 19) . . . . .	12
Interference Analyzer (Option 25) . . . . .	12
Channel Scanner (Option 27) . . . . .	12
GPS (Option 31) . . . . .	13
Ethernet Connectivity (Option 411) . . . . .	13
Distance Domain . . . . .	13
Coverage Mapping (Option 431) . . . . .	13
AM/FM/PM Demodulation Analyzer (Option 509) . . . . .	14
Line Sweep Tools . . . . .	15
Master Software Tools . . . . .	15
General Specifications . . . . .	16
Instrument Options . . . . .	18
Standard Accessories . . . . .	18
Optional Accessories . . . . .	18

## Definitions

	All specifications and characteristics apply under the following conditions, unless otherwise noted:
Warm-Up Time	After 15 minutes of warm-up time in VNA mode, where the instrument is left in the ON state.
Temperature Range	Over the 23 °C ± 5 °C temperature range, unless otherwise noted.
Reference Signal	When using internal reference signal.
Typical Performance	Typical specifications that are not in parenthesis are not tested and not warranted. They are generally representative of characteristic performance. Typical specifications in parenthesis ( ) represent the mean value of measured units and do not include any guard-bands or uncertainties. They are not warranted.
Uncertainty	A coverage factor of x1 is applied to the measurement uncertainties to facilitate comparison with other industry handheld analyzers.
Calibration Cycle	Calibration is within the recommended 12 month period (residual specifications also require calibration kit calibration cycle adherence.)
	All specifications subject to change without notice. For the most current data sheet, please visit the Anritsu web site: <a href="http://www.anritsu.com">www.anritsu.com</a>



## VNA Performance Specifications

### Block Diagram

As shown in the following block diagram, the VNA Master has a 2-port, 1-path architecture that automatically measures 2 S-parameters with error-correction precision inherent to VNA operation. The above illustration is a simplified block diagram of the VNA Master 2-port, 1-path architecture. The magnitude AND phase information gained from Vector Network data enables the VNA Master to provide improved field measurements with greater accuracy.

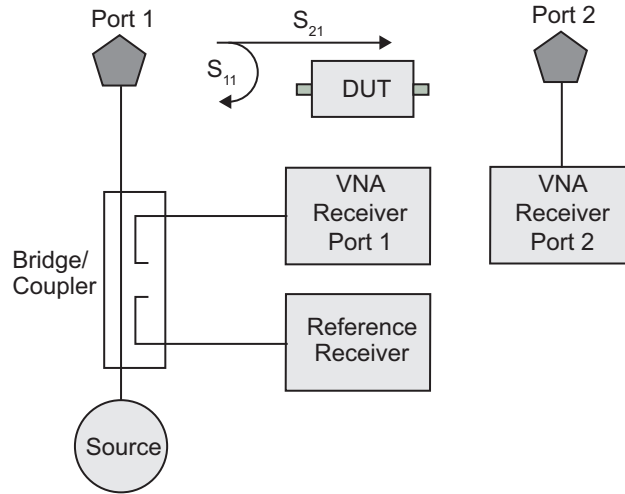

### Frequency

MS2024/34B	500 kHz to 4 GHz
MS2025/35B	500 kHz to 6 GHz
Frequency Accuracy	2.5 ppm
Frequency Resolution	1 Hz

### Test Port Power (Typical)

VNA Master supports selection of High, Default, or Low test port power. Changing power after calibration can degrade the calibrated performance. Typical power by bands:

Frequency Range	High Port Power (dBm)	Default Port Power (dBm)	Low Port Power (dBm)
500 kHz to < 3 GHz	+3	-5	-25
3 GHz to 6 GHz	0	-5	-25

### Transmission Dynamic Range

The transmission dynamic range (the difference between test port power and noise floor) using 10 Hz IF Bandwidth and High Port Power:

2 MHz to ≤ 4 GHz	100 dB
4 GHz to ≤ 6 GHz	90 dB

### Sweep Speed (Typical)

Sweep speed in μs/point for IF Bandwidth of 100 kHz, 1001 data points, and single display. The two-receiver architecture will simultaneously collect S<sub>21</sub> and S<sub>11</sub> in a single sweep.

500 kHz to 6 GHz	850 μs/point
------------------	--------------

### Noise Floor

Frequency	Noise Floor (typical)
500 kHz to 3 GHz	-100 dBm
3 GHz to 4 GHz	-103 dBm
4 GHz to 6 GHz	-93 dBm

### Temperature Stability (S<sub>11</sub> or S<sub>21</sub>, Short, 23 °C ± 5 °C)

Frequency Range	Magnitude (typical)	Phase (typical)
500 kHz to 6 GHz	0.020 dB/°C	0.200 deg/°C

### Interference Immunity

On-Channel	+17 dBm at > 1.0 MHz from carrier frequency
On-Frequency	0 dBm within ± 10 kHz of the carrier frequency



## VNA Functional Specifications

### Measurements

Measurement Parameters	$S_{11}$ , $S_{21}$
Number of Traces	Four: TR1, TR2, TR3, TR4
Trace Format	Single, Dual, Tri, Quad. When used with Number of Traces, overlays are possible including a Single Format with Four trace overlays.
Graph Types	Log Magnitude, SWR, Phase, Real, Imaginary, Group Delay, Smith Chart, Log Mag/2 (1-Port Cable Loss), Linear Polar, Log Polar, Real Impedance, Imaginary Impedance
Domains	Frequency Domain, Distance Domain
Frequency	Start Frequency, Stop Frequency, Center Frequency, Span
Distance	Start Distance, Stop Distance
Frequency Sweep Type: Linear	Single Sweep, Continuous
Data Points	2 to 4001 (arbitrary setting); data points can be reduced without recalibration.
Limit Lines	Upper, Lower, 10 segmented Upper, 10 segmented Lower
Test Limits	Pass/Fail for Upper, Pass/Fail for Lower, Limit Audible Alarm
Data Averaging	Sweep-by-sweep
Smoothing	0 to 20 %
IF Bandwidth	10, 20, 50, 100, 200, 500, 1 k, 2 k, 5 k, 10 k, 20 k, 50 k, 100 k (Hz)
Reference Plane	The reference planes of a calibration (or other normalization) can be changed by entering a line length. Assumes no loss, flat magnitude, linear phase, and constant impedance.
Auto Reference Plane Extension	Instead of manually entering a line length, this feature automatically adjusts phase shift from the current calibration (or other normalization) to compensate for external cables (or test fixtures). Assumes no loss, flat magnitude, linear phase, and constant impedance.
Frequency Range	Frequency range of the measurement can be narrowed (reduces number of data points) within the calibration range without recalibration. When Interpolation is On, narrowed frequency range will retain original number of data points.
Group Delay Aperture	Defined as the frequency span over which the phase change is computed at a given frequency point. The aperture can be changed without recalibration. The minimum aperture is the frequency range divided by the number of points in calibration and can be increased to 20% of the frequency range.
Group Delay Range	< 180° of phase change within the aperture
Trace Memory	A separate memory for each trace can be used to store measurement data for later display. The trace data can be saved and recalled.
Trace Math	Complex trace math operations of subtraction, addition, multiplication, or division are provided.
Number of Markers	Eight, arbitrary assignments to any trace
Marker Types	Reference, Delta
Marker Readout Styles	Log Mag, Cable Loss (Log Mag/2), Log Mag and Phase, Phase, Real and Imaginary, SWR, Impedance, Admittance, Normalized Impedance, Normalized Admittance, Polar Impedance, and Group Delay
Marker Search	Peak Search, Valley Search, Find Marker Value
Calibration Type	Full $S_{11}$ , 1-Path, 2-Port ( $S_{11}$ and $S_{21}$ ), Response $S_{11}$ , Response $S_{21}$
Calibration Methods	Short-Open-Load-Through (SOLT)
Calibration Standards' Coefficients	Coax: N-Connector, K-Connector, 7/16, TNC, SMA, and four User Defined
Cal Correction Toggle	On/Off
Interpolation	On/Off (Interpolation may be activated before or after calibration)
Impedance Conversion (Smith Chart)	Support for 50 $\Omega$ and 75 $\Omega$ are provided.
Units	Meters, Feet
Bias Tee Settings	Internal, Off
Timebase Reference	Internal
File Storage Types	Measurement, Setup (with CAL), Setup (without CAL), S2P (Real/Imag), S2P (Lin Mag/Phase), S2P (Log Mag/Phase), JPEG
Ethernet Configuration	DHCP or Manual (Static); IP, Gateway, Subnet entries
Languages	English, French, German, Spanish, Chinese, Japanese, Korean, Italian, Russian plus one User Defined

**Corrected System Performance and Uncertainties – High Port Power, N-Type**

**Measurement Accuracy**<sup>1</sup> OSLN50A-8 or OSLNF50A-8, TOSLN50A-8 or TOSLNF50A-8.

Frequency Range	Directivity (dB)	Source Match (dB)	Reflection Tracking (dB)	Transmission Tracking (dB)
< 20 MHz	≥ 42	≥ 30	± 0.01	± 0.01
20 MHz to < 3 GHz	≥ 42	≥ 30	± 0.05	± 0.01
3 GHz to 6 GHz	≥ 42	≥ 30	± 0.05	± 0.01

**Corrected Measurement Uncertainty (Transmission from Port 1 to Port 2)**

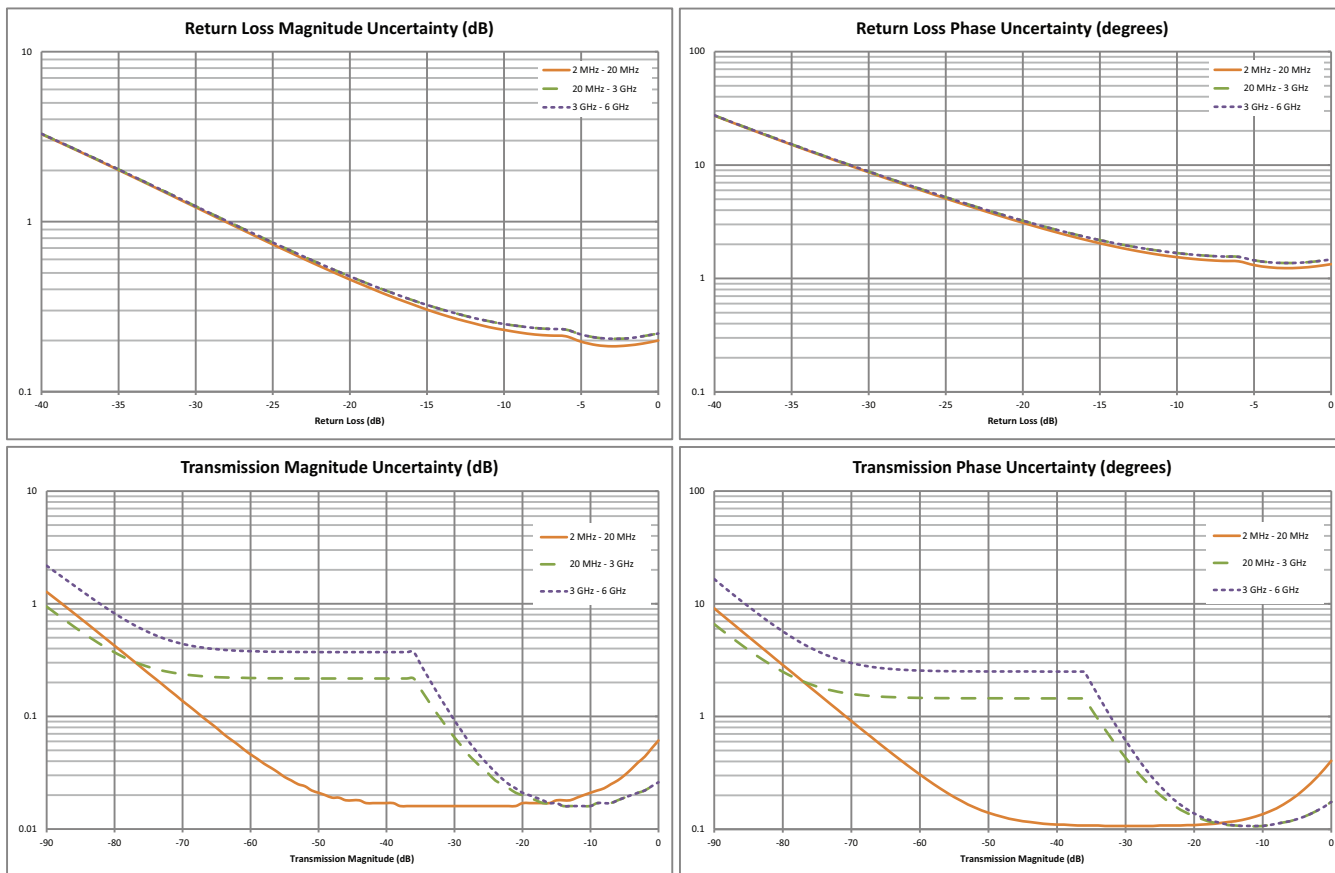

1. Full 1-path, 2-port forward path calibration with isolation, high power, 10 Hz IFBW, no averaging, 10 minute warm-up. OSLN50A-8, OSLNF50A-8, TOSLN50A-8, or TOSLNF50A-8 calibration kit. Reflection and Transmission Tracking are typical.

**Corrected System Performance and Uncertainties – High Port Power, K-Type**

**Measurement Accuracy**<sup>1</sup> TOSLK50A-20 or TOSLKF50A-20. Compatible with 3.5 mm and SMA connectors.

Frequency Range	Directivity (dB)	Source Match (dB)	Reflection Tracking (dB)	Transmission Tracking (dB)
< 20 MHz	≥ 42	≥ 33	± 0.01	± 0.01
20 MHz to < 3 GHz	≥ 42	≥ 33	± 0.05	± 0.01
3 GHz to 6 GHz	≥ 42	≥ 33	± 0.05	± 0.01

**Corrected Measurement Uncertainty** (Transmission from Port 1 to Port 2)

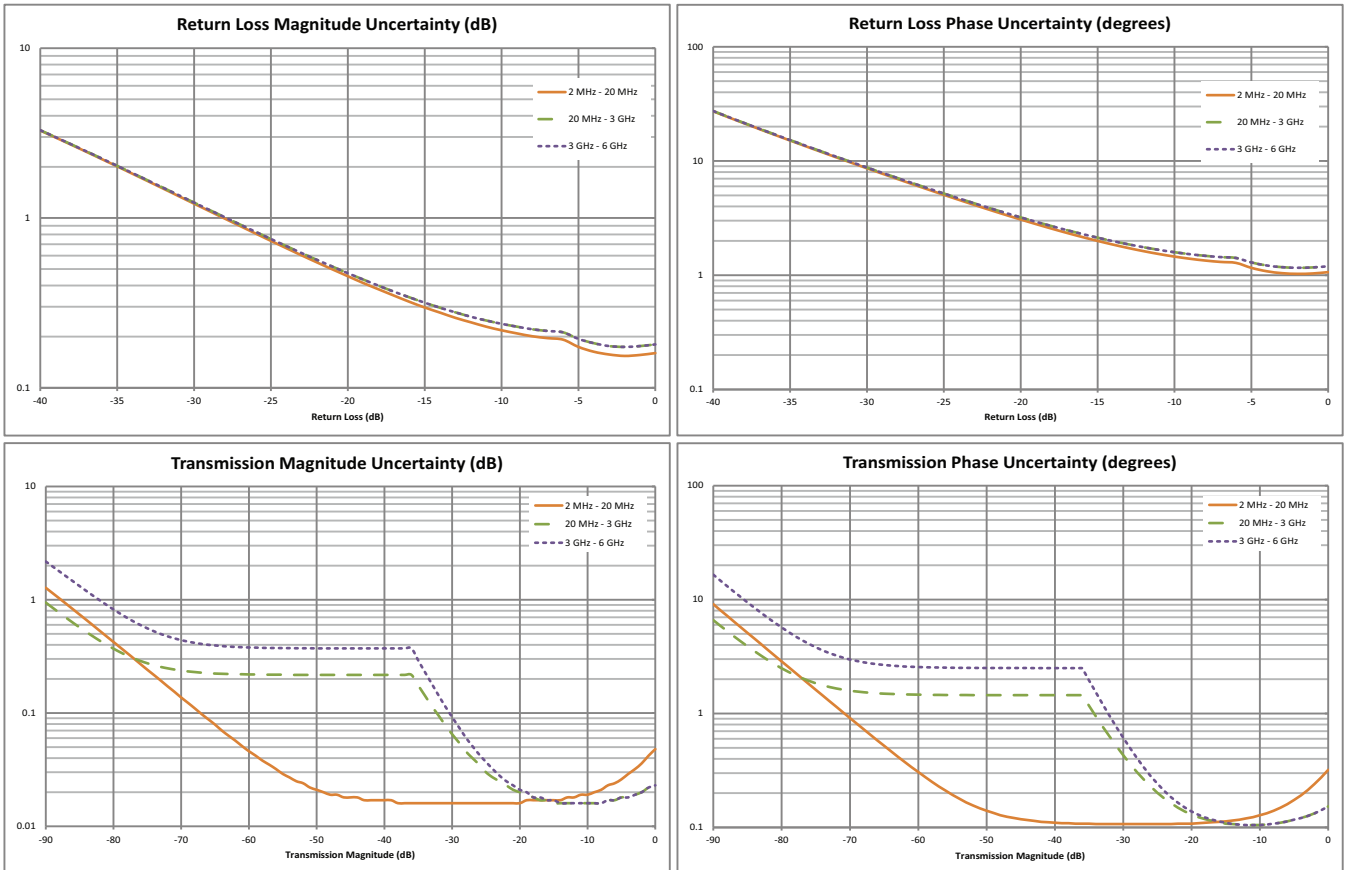

1. Full 1-path, 2-port forward path calibration with isolation, high power, 10 Hz IFBW, no averaging, 10 minute warm-up. TOSLK50A-20, TOSLKF50A-20 calibration kit. Reflection and Transmission Tracking are typical.



## Spectrum Analyzer Performance Specifications (Models MS203xB only)

### Frequency

Frequency Range	MS2034B: 9 kHz to 4 GHz, (tunable to 0 Hz) MS2035B: 9 kHz to 6 GHz, (tunable to 0 Hz)
Frequency Span	MS2034B: 10 Hz to 4 GHz including zero span MS2035B: 10 Hz to 6 GHz including zero span
Tuning Resolution	1 Hz
Frequency Reference Aging	± 1.0 ppm/year
Frequency Reference Accuracy	± 1.5 ppm (25 °C ± 25 °C) + aging, < ± 50 ppb with GPS On
Sweep Time	Minimum 100 ms, 10 µs to 600 seconds in zero span
Sweep Time Accuracy	± 2 % in zero span

### Bandwidth

Resolution Bandwidth (RBW)	10 Hz to 3 MHz in 1–3 sequence ± 10 % (1 MHz max in zero-span) (–3 dB bandwidth)
Video Bandwidth (VBW)	1 Hz to 3 MHz in 1–3 sequence (–3 dB bandwidth) (auto or manually selectable)
RBW with Quasi-Peak Detection	200 Hz, 9 kHz, 120 kHz (–6 dB bandwidth)
VBW with Quasi-Peak Detection	Auto VBW is On, RBW/VBW = 1

### Spectral Purity

SSB Phase Noise @ 1 GHz	–100 dBc/Hz, –110 dBc/Hz typical @ 10 kHz offset –105 dBc/Hz, –112 dBc/Hz typical @ 100 kHz offset –115 dBc/Hz, –121 dBc/Hz typical @ 1 MHz offset
-------------------------	--

### Amplitude

Dynamic Range	> 95 dB (2.4 GHz), 2/3 (TOI-DANL) in 10 Hz RBW
Measurement Range	DANL to +26 dBm (≥ 50 MHz) DANL to 0 dBm (< 50 MHz)
Maximum Continuous Input	+30 dBm Peak, ± 50 VDC (≥ 10 dB attenuation)
Display Range	1 to 15 dB/div in 1 dB steps, ten divisions displayed
Reference Level Range	–120 dBm to +30 dBm
Attenuator Resolution	0 to 55 dB, 5.0 dB steps
Units	Log Scale Modes: dBm, dBV, dBmV, dBµV Linear Scale Modes: nV, µV, mV, V, kV, nW, µW, mW, W, kW
Accuracy	9 kHz to 100 kHz: ± 2.0 dB typical (Preamp Off) <sup>1</sup> 100 kHz to 4.0 GHz: ± 1.25 dB, ± 0.5 dB typical > 4.0 GHz to 6 GHz: ± 1.50 dB, ± 0.5 dB typical

1. Applicable for models beginning with serial number 1441xxx only.



**Spectrum Analyzer Performance Specifications** (Models MS203xB only) (continued)

**DANL**

Displayed Average Noise Level (DANL)  (RBW Normalized to 1 Hz, 0 dB attenuation)	Preamp Off (Reference level -20 dBm)		Preamp On (Reference level -50 dBm)	
	Maximum	Typical	Maximum	Typical
10 MHz to 2.4 GHz	-141 dBm	-146 dBm	-157 dBm	-162 dBm
> 2.4 GHz to 4 GHz	-137 dBm	-141 dBm	-154 dBm	-159 dBm
> 4 GHz to 5 GHz	-134 dBm	-138 dBm	-150 dBm	-155 dBm
> 5 GHz to 6 GHz	-126 dBm	-131 dBm	-143 dBm	-150 dBm
(RBW = 10 Hz, 0 dB attenuation)				
10 MHz to 2.4 GHz	-131 dBm	-136 dBm	-147 dBm	-152 dBm
> 2.4 GHz to 4 GHz	-127 dBm	-131 dBm	-144 dBm	-149 dBm
> 4 GHz to 5 GHz	-124 dBm	-128 dBm	-140 dBm	-145 dBm
> 5 GHz to 6 GHz	-116 dBm	-121 dBm	-133 dBm	-140 dBm

**Spurs**

Residual Spurious	< -90 dBm (RF input terminated, 0 dB input attenuation, > 10 MHz)
Input-Related Spurious	< -75 dBc (0 dB attenuation, -30 dBm input, span < 1.7 GHz, carrier offset > 4.5 MHz)
Exceptions, typical	< -70 dBc @ < 2.5 GHz with 2072.5 MHz Input
	< -68 dBc @ F1 - 280 MHz with F1 Input
	< -70 dBc @ F1 + 190.5 MHz with F1 Input
	< -52 dBc @ 7349 - 2F2 MHz, with F2 Input, where F2 < 2424.5 MHz

**Second Harmonic Distortion**

	Preamp Off, 0 dB input attenuation, -30 dBm input
50 MHz	-56 dBc
> 50 MHz to 200 MHz	-60 dBc, typical
> 200 MHz to 3000 MHz	-70 dBc, typical
VSWR	2:1, typical

**Third-Order Intercept (TOI)**

	Preamp Off, -20 dBm tones 100 kHz apart, 10 dB attenuation
800 MHz	+16 dBm
2400 MHz	+20 dBm
200 MHz to 2200 MHz	+25 dBm, typical
> 2.2 GHz to 5.0 GHz	+28 dBm, typical
> 5.0 GHz to 6.0 GHz	+33 dBm, typical



## Spectrum Analyzer Functional Specifications (Models MS203xB only)

### Measurements

Measurements	Field Strength (uses antenna calibration tables to measure dBm/m <sup>2</sup> , dBmV/m, dBV/m, dBμV/m, Volt/m, Watt/m <sup>2</sup> , dBW/m <sup>2</sup> , A/m, dBA/m and Watt/cm <sup>2</sup> ) Occupied Bandwidth (measures 99 % to 1 % power channel of a signal) Channel Power (measures the total power in a specified bandwidth) ACPR (Adjacent Channel Power Ratio) AM/FM/SSB Demodulation (Wide/Narrow FM, AM, Upper/Lower SSB), (audio out only) C/I (carrier-to-interference ratio) Emission Mask Coverage Mapping (requires Option 431 and Option 31)
--------------	--

### Setup Parameters

Frequency	Center/Start/Stop, Span, Frequency Step, Signal Standard, Channel #, Channel Increment
Amplitude	Reference Level (RL), Scale, Attenuation Auto/Level, RL Offset, Pre-Amp On/Off, Detection
Span	Span, Span Up/Down (1-2-5), Full Span, Zero Span, Last Span
Bandwidth	RBW, Auto RBW, VBW, Auto VBW, RBW/VBW, Span/RBW
File	Save, Recall, Delete, Directory Management
Save/Recall	Setups, Measurements, Limit Lines, Screen Shots JPEG (save only), Save-on-Event
Save-on-Event	Crossing Limit Line, Sweep Complete, Save-then-Stop, Clear All
Delete	Selected File, All Measurements, All Mode Files, All Content
Directory Management	Sort Method (Name/Type/Date), Ascend/Descend, Internal/USB, Copy, Format USB
Application Options	Bias-Tee (On/Off), Impedance (50 Ω, 75 Ω, Other)

### Sweep Functions

Sweep	Single/Continuous, Manual Trigger, Reset, Detection, Minimum Sweep Time, Trigger Type
Detection	Peak, RMS, Negative, Sample, Quasi-peak
Triggers	Free Run, External, Video, Change Position, Manual

### Trace Functions

Traces	Up to three Traces (A, B, C), View/Blank, Write/Hold, Trace A/B/C Operations
Trace A Operations	Normal, Max Hold, Min Hold, Average, # of Averages, (always the live trace)
Trace B Operations	A → B, B ↔ C, Max Hold, Min Hold
Trace C Operations	A → C, B ↔ C, Max Hold, Min Hold, A - B → C, B - A → C, Relative Reference (dB), Scale

### Marker Functions

Markers	Markers 1-6 each with a Delta Marker, or Marker 1 Reference with Six Delta Markers, Marker Table (On/Off), All Markers Off
Marker Types	Style (Fixed/Tracking), Noise Marker, Frequency Counter Marker Marker Auto-Position Peak Search, Next Peak (Right/Left), Peak Threshold %, Set Marker to Channel, Marker Frequency to Center, Delta Marker to Span, Marker to Reference Level
Marker Table	1-6 markers frequency and amplitude plus delta markers frequency offset and amplitude

### Limit Line Functions

Limit Lines	Upper/Lower, On/Off, Edit, Move, Envelope, Advanced, Limit Alarm, Default Limit
Limit Line Edit	Frequency, Amplitude, Add Point, Add Vertical, Delete Point, Next Point Left/Right
Limit Line Move	To Current Center Frequency, By dB or Hz, To Marker 1, Offset from Marker 1
Limit Line Envelope	Create Envelope, Update Amplitude, Number of Points (41 max), Offset, Shape Square/Slope
Limit Line Advanced	Type (Absolute/Relative), Mirror, Save/Recall



### Bias Tee (Option 10)

#### Bias Tee Measurements

For tower mounted amplifier tests, the MS202xB/MS203xB series with optional internal bias tees can supply both DC and RF signals on the center conductor of the cable during measurements. For frequency sweeps in excess of 2 MHz, the VNA Master can supply internal voltage control from +12 to +32 V in 0.1 V steps up to 450 mA. Bias can be directed to VNA Port 2 or to the Spectrum Analyzer Input Port (MS203xB).

#### Bias Tee Specifications

Frequency Range	
MS20x4B	2 MHz to 4 GHz
MS20x5B	2 MHz to 6 GHz
Internal Voltage/Current	+12 V to +32 V at 450 mA (1 A surge for 100 ms)
Internal Resolution	0.1 V
Bias Tee Selections	Internal, Off

The Compact VNA Master offers optional integrated bias tee for supplying DC plus RF to the DUT as shown in this simplified block diagram.

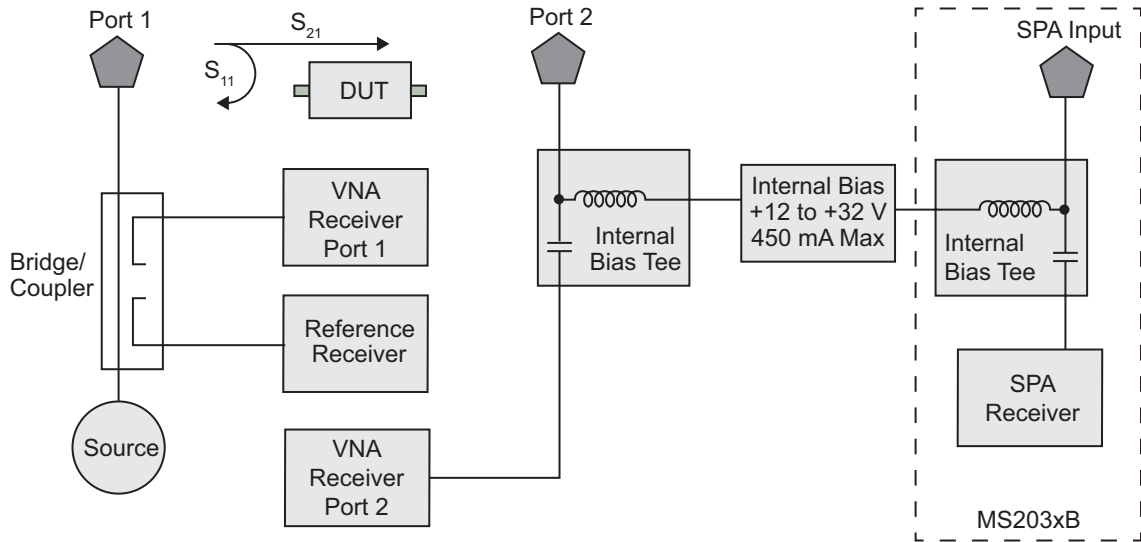

### Vector Voltmeter (Option 15)

A phased array system relies on phase matched cables for nominal performance. For this class of application, the VNA Master offers this special software mode to simplify phase matching cables at a single frequency. The similarity between the popular vector voltmeter and this software mode ensures minimal training is required to phase match cables. Operation is as simple as configuring the display for absolute or relative measurements. The easy-to-read large fonts show either reflection or transmission measurements using impedance, magnitude, or VSWR readouts. For instrument landing system (ILS) or VHF Omnidirectional Range (VOR) applications, a table view improves operator efficiency when phase matching up to twelve cables. The MS202xB/MS203xB solution is superior because the signal source is included internally, precluding the need for an external signal generator.

#### VVM Specifications

CW Frequency Range	500 kHz to 4/6 GHz
Source Power	High, Default, Low
IFBW	10 Hz to 100 kHz in 1-2-5 sequence
Measurement Display	CW, Table (twelve entries, plus reference)
Measurement Types	Return Loss, Insertion
Measurement Format	dB/VSWR/Impedance



**High Accuracy Power Meter (Option 19)** (Requires external USB power sensor)

Conduct precise measurements of CW and digitally modulated transmitters in the field using this VNA Master software mode with a separately purchased Anritsu USB power sensor. After specifying the center frequency and zeroing the sensor to ensure accuracy at low power levels, the software offers intuitive operation for absolute and relative readouts in dBm or Watts.

Amplitude	Maximum, Minimum, Offset, Relative On/Off, Units, Auto Scale
Average	# of Running Averages, Max Hold
Zero/Cal	Zero On/Off, Cal Factor (Center Frequency, Signal Standard)
Limits	Limit On/Off, Limit Upper/Lower

Power Sensor Model	PSN50	MA24105A	MA24106A	MA24108A/18A/26A
Description	High Accuracy RF Power Sensor	Inline High Power Sensor	High Accuracy RF Power Sensor	Microwave USB Power Sensor
Frequency Range	50 MHz to 6 GHz	350 MHz to 4 GHz	50 MHz to 6 GHz	10 MHz to 8/18/26.5 GHz
Connector	Type N(m), 50 Ω	Type N(f), 50 Ω	Type N(m), 50 Ω	Type N(m), 50 Ω (8/18 GHz)
Dynamic Range	-30 dBm to +20 dBm (0.001 mW to 100 mW)	+3 dBm to +51.76 dBm (2 mW to 150 W)	-40 dBm to +23 dBm (0.1 μW to 200 mW)	-40 dBm to +20 dBm (0.1 μW to 100 mW)
VBW	100 Hz	100 Hz	100 Hz	50 kHz
Measurand	True-RMS	True-RMS	True-RMS	True-RMS, Slot Power, Burst Average Power
Measurement Uncertainty	± 0.16 dB <sup>1</sup>	± 0.17 dB <sup>2</sup>	± 0.16 dB <sup>1</sup>	± 0.18 dB <sup>3</sup>
Data sheet (for complete specifications)	11410-00414	11410-00621	11410-00424	11410-00504

- Notes:
1. Total RSS measurement uncertainty (0 °C to 50 °C) for power measurements of a CW signal greater than -20 dBm with zero mismatch errors.
  2. Expanded uncertainty with K=2 for power measurements of a CW signal greater than +20 dBm with a matched load. Measurement results referenced to the input side of the sensor.
  3. Expanded uncertainty with K=2 for power measurements of a CW signal greater than -20 dBm with zero mismatch errors.



**Interference Analyzer (Option 25)** (Models MS203xB only, GPS Option 31 recommended)

**Measurements**

Spectrum	Field Strength Occupied Bandwidth Channel Power Adjacent Channel Power (ACPR) AM/FM/SSB Demodulation (Wide/Narrow FM, Upper/Lower SSB - audio out only) Carrier-to-Interference ratio (C/I)
Spectrogram	Collect data up to one week
Signal Strength	Gives visual and aural indication of signal strength
Received Signal Strength Indicator (RSSI)	Collect data up to one week
Signal ID	Up to 12 signals Center Frequency Bandwidth Signal Type: FM, GSM, W-CDMA, CDMA, Wi-Fi Closest Channel Number Number of Carriers
Signal-to-Nose Ratio (SNR)	> 10 dB
Interference Mapping	Triangulate location of interference with on-display maps
Application Options	Bias-Tee (On/Off), Impedance (50 Ω, 75 Ω, Other)



**Channel Scanner (Option 27)** (Models MS203xB only, GPS Option 31 recommended)

**General**

Number of Channels	1 to 20 Channels
Measurements	Graph/Table, Max Hold (On/5 s/Off), Freq/Channel, Current/Max, Single/Dual Color
Scanner	Scan Channels, Scan Frequencies, Scan Customer List, Scan Script Master™
Amplitude	Reference Level, Scale
Custom Scan	Signal Standard, Channel, # of Channels, Channel Step Size, Custom Scan
Frequency Range	9 kHz to 4 GHz (MS2034B), 9 kHz to 6 GHz (MS2035B)
Frequency Accuracy	± 10 Hz + Time base error
Measurement Range	-110 dBm to +26 dBm
Application Options	Bias-Tee (On/Off), Impedance (50 Ω, 75 Ω, Other)



### GPS (Option 31) (requires external GPS antenna, sold separately.)

Built-in GPS provides location information (latitude, longitude, altitude) and Universal Time (UT) information for storage along with trace data so that you can later verify that measurements were taken at the right location. The GPS option requires a separately ordered Anritsu GPS antenna. Frequency accuracy is enhanced for the Spectrum Analyzer (on MS203xB models) when GPS is active and has achieved satellite lock.

#### GPS Specifications

Setup	On/Off, Antenna Voltage 3.3/5.0 V, GPS Info
GPS Time/Location Indicator	Time, Latitude, Longitude and Altitude on display Time, Latitude, Longitude and Altitude with trace storage
High Frequency Accuracy	Spectrum Analyzer, Interference Analyzer, CW Signal Analyzers < ± 50 ppb with GPS On, GPS antenna connected, 3 minutes after satellite lock in selected mode
Connector	SMA, Female

### Ethernet Connectivity (Option 411)

Connector	RJ45
LAN Speed	10 Mbps
Mode	Static, DHCP
Static IP settings	IP address Subnet Mask IP Gateway
Remote Control	Fully remote programmable via SCPI commands and/or remote access utility provided with Master Software Tools
Data Upload	With Line Sweep Tools or Master Software Tools through a LAN connection



### Distance Domain (Formerly Option 501, now standard with firmware v1.20 or greater)

Distance-to-Fault Analysis (standard with firmware v1.20 and above) is a powerful field test tool to analyze cables for faults, including minor discontinuities that may occur due to a loose connection, corrosion, or other aging effects. By using Frequency Domain Reflectometry (FDR), the Compact VNA Master exploits a user-specified band of full power operational frequencies (instead of DC pulses from TDR approaches) to more precisely identify discontinuities. The Compact VNA Master converts S-parameters from frequency domain into distance domain on the horizontal display axis, using a mathematical computation called Inverse Fourier Transform. Connect a reflection at the opposite end of the cable, and the discontinuities appear versus distance to reveal any potential maintenance issues. When access to both ends of the cable is convenient, a similar distance domain analysis is available on transmission measurements.

Distance Domain, will improve your productivity with displays of the cable in terms of discontinuities versus distance. This readout can then be compared against previous measurements (from stored data) to determine whether any degradations have occurred since installation (or the last maintenance activity). More importantly, you will know precisely where to go to fix the problem and so minimize or prevent downtime of the system.



### Coverage Mapping (Option 431) (Models MS203xB only. Requires GPS)

#### Measurements

Indoor Mapping	RSSI and ACPR
Outdoor Mapping	RSSI and ACPR

#### Setup Parameters

Frequency	Center/Start/Stop, Span, Freq Step, Signal Standard, Channel #, Channel Increment
Amplitude	Reference Level (RL), Scale, Attenuation Auto/Level, RL Offset, Pre-Amp On/Off, Detection
Span	Span, Span Up/Down (1-2-5), Full Span, Zero Span, Last Span
BW	RBW, Auto RBW, VBW, Auto VBW, RBW/VBW, Span/VBW
Measurement Setup	ACPR, RSSI
Point Distance / Time Setup	Repeat Type Time Distance
Save Points Map	Save KML, JPEG, Tab Delimited
Recall Points Map	Recall Map, Recall KML Points only, Recall KML Points with Map, Recall Default Grid



**AM/FM/PM Demodulation Analyzer (Option 509)** (Models MS203xB only)

**Measurements**

Display Type	RF Spectrum AM/FM/PM	Audio Spectrum (AM)	Audio Spectrum (FM/PM)	Audio Waveform (AM)	Audio Waveform (FM/PM)	Summary (AM)	Summary (FM/PM)
Graphic Display	Power (dBm) vs. Frequency	Depth (%) vs. Modulation Frequency	Deviation (kHz/rad) vs. Modulation Frequency	Depth (%) vs. Time	Deviation (kHz/rad) vs. Time	None	None
Numerical Displays	Carrier Power Carrier Frequency Occupied Bandwidth	AM Rate RMS Depth (Pk-Pk)/2 Depth SINAD* THD* Distortion/Total Vrms*	FM/PM Rate RMS Deviation (Pk-Pk)/2 Deviation SINAD* THD* Distortion/Total Vrms*	AM Rate RMS Depth (Pk-Pk)/2 Depth SINAD* THD* Distortion/Total Vrms*	FM/PM Rate RMS Depth (Pk-Pk)/2 Depth SINAD* THD* Distortion/Total Vrms*	RMS Depth (AM) Peak + Depth Peak - Depth (Pk-Pk)/2 Depth Carrier Power Carrier Frequency Occupied Bandwidth AM Rate SINAD* THD* Distortion/Total Vrms*	RMS Deviation (FM/PM) Peak + Depth Peak - Depth (Pk-Pk)/2 Depth Carrier Power Carrier Frequency Occupied Bandwidth AM Rate SINAD* THD* Distortion/Total Vrms*

\* Requires Sinewave modulation

**Setup Parameters**

Frequency	Center Freq, Span, Freq Step, Signal Standard, Channel, Channel Increment, Set Carrier Freq
Amplitude	Scale, Power Offset, Adjust Range
Setup	Demod Type (AM, FM, PM), IFBW, Auto IFBW
Measurements	RF Spectrum AM/FM/PM, Audio Spectrum (AM/FM/PM), Audio Waveform (AM/FM/PM), Summary (AM/FM/PM), Average
Marker	On/Off, Delta, Peak Search, Marker Freq to Center, Marker to Ref Lvl, Marker Table, All Markers Off

**Specifications**

AM	Modulation Rate: $\pm 1$ Hz (< 100 Hz), $\pm 2$ % (> 100 Hz) Depth: $\pm 5$ % for (Modulation rates 10 Hz to 100 kHz)
FM	Modulation Rate: $\pm 1$ Hz (< 100 Hz); $\pm 2$ % (100 Hz to 100 kHz) Deviation Accuracy: $\pm 5$ % (100 Hz to 100 kHz)**
PM	Modulation Rate: $\pm 1$ Hz (< 100 Hz); $\pm 2$ % (100 Hz to 100 kHz) Deviation Accuracy: $\pm 5$ % (deviation 0 to 93 rad, rate 10 Hz to 5 kHz)**
IF bandwidth	1 kHz to 300 kHz in 1-3 sequence
Frequency Span	RF Spectrum: 10 kHz to 10 MHz Audio Spectrum: 2 kHz, 5 kHz, 10 kHz, 20 kHz, 70 kHz, 140 kHz
RBW/VBW	30
Span/RBW	100
Sweep time	50 $\mu$ s to 50 ms (Audio Waveform)
**	IFBW must be greater than 95 % occupied BW

**Line Sweep Tools** (for your PC)**Trace Capture**

Browse to Instrument	View and copy traces from the test equipment to your PC using Windows Explorer
Open Legacy Files	Open DAT files captured with Hand Held Software Tools v6.61
Open Current Files	Open VNA or DAT files
Capture plots To	The Line Sweep Tools screen, DAT files, Database, or JPEG

**Traces**

Trace Types	Return Loss, VSWR, DTF-RL, DTF-VSWR, Cable Loss, Smith Chart, and PIM
Trace Formats	DAT, VNA, CSV, PNG, BMP, JPG, HTML, Data Base, and PDF

**Report Generation**

Report Generator	Includes GPS location along with measurements
Report Format	Create reports in HTML or PDF format
Report Setup	Report Title, Company, Prepared for, Location, Date and Time, Filename, Company logo
Trace Setup	1 trace Portrait Mode, 2 Trace Portrait Mode, 1 Trace Landscape Mode

**Trace Validation**

Presets	7 presets allow "one click" setting of up to 6 markers and one limit line
Marker Controls	6 regular Markers, Marker Peak, Marker valley, Marker between, and frequency entry
Delta Markers	6 Delta markers
Limit Line	Enable and drag or value entry. Also works with presets
Next Trace Button	Next Trace and Previous trace arrow keys allow quick switching between traces

**Tools**

Cable Editor	Allows creation of custom cable parameters
Distance to Fault	Converts a Return Loss trace to a Distance to Fault trace
Measurement Calculator	Converts Real, Imaginary, Magnitude, Phase, RL, VSWR, Rho, and Transmit power
Signal Standard Editor	Creates new band and channel tables
Renaming Grid	36 user definable phrases for creation of file names, trace titles, and trace subtitles

**Connectivity**

Connections	Ethernet, USB cable, USB Memory Stick
-------------	---------------------------------------

**Master Software Tools** (for your PC)**Mapping** (GPS Required)

Spectrum Analyzer Mode	MapInfo, MapPoint
Mobile WiMAX OTA, LTE OTA Options	Google Earth, Google Maps, MapInfo

**Folder Spectrogram** (Spectrum Monitoring for Interference Analysis and Spectrum Clearing)

Folder Spectrogram – 2D View	Creates a composite file of multiple traces Peak Power, Total Power, Peak Frequency, Histogram, Average Power (Max/Min) File Filter (Violations over limit lines or deviations from averages) Playback
Video Folder Spectrogram – 2D View	Create AVI file to export for management review/reports
Folder Spectrogram – 3D View	Views (Set Threshold, Markers) - 3D (Rotate X, Y, Z Axis, Level Scale, Signal ID) - Playback (Frequency and/or Time Domain)

**List/Parameter Editors**

Traces	Add, delete, and modify limit lines and markers
Product Updates	Auto-checks Anritsu website for latest revision firmware
Pass/Fail	Create, download, or edit Signal Analysis Pass/Fail Limits
Languages	Add custom language or modify non-English language menus

**Script Master™**

Channel Scanner Mode	Automate scan up to 1200 channels, repeat for sets of 20 channels, repeat all channels
GSM/GPRS/EDGE or W-CDMA/HSPA+ Mode	Automate Signal Analysis testing requirements with annotated how-to pictures

**Connectivity**

Connections	Connect to PC using USB, Ethernet
-------------	-----------------------------------



## General Specifications

### Maximum Input

	(Damage Level)
VNA Port 1 or 2	+23 dBm, $\pm$ 50 VDC
Spectrum Analyzer Port	+30 dBm peak, $\pm$ 50 VDC, Maximum Continuous Input, $\geq$ 10 dB attenuation (Models MS203xB, spectrum analyzer input port only)

### Setup Parameters

System	Status (Temperature, Battery Info, Serial Number, Firmware Version, Options Installed) Self Test, Application Self Test GPS (see Option 31)
System Options	Name, Date and Time, Ethernet Configuration, Brightness, Volume, Language (English, French, German, Spanish, Chinese, Japanese, Korean, Italian, Russian, User defined), Reset (Factory Defaults, Master Reset, Update Firmware)
File	Save, Recall, Copy, Delete, Directory Management
Save/Recall	Setups, Measurements, Screen Shots JPEG (save only), Limit Lines
Copy	Setups, Measurements, Screen Shots JPEG
Delete	Selected File, All Measurements, All Mode Files, All Content
Directory Management	Sort Method (Name/Type/Date), Ascend/Descend, Internal/USB, Copy, Format USB
Internal Trace/Setup Memory	2000 traces, 2000 setups
External Trace/Setup Memory	Limited by size of USB Flash drive
Mode Switching	Auto-Stores/Recalls most recently used Setup Parameters in the Mode

### Connectors

VNA Port 1 or 2	Type N, female, 50 $\Omega$
Spectrum Analyzer Port	Type N, female, 50 $\Omega$ (MS203xB only)
GPS	SMA, female
External Power	5.5 mm barrel connector, 12.5 VDC to 15 VDC, < 4.0 Amps
USB Interface (2)	Type A, Connect Flash Drive and Power Sensor
USB Interface	5-pin mini-B, Connect to PC for data transfer
Headset Jack	3.5 mm barrel connector
External Reference In	BNC, female, Maximum Input $\pm$ 5 VDC 1 MHz, 5 MHz, 10 MHz, 13 MHz
External Trigger/Clock Recovery	BNC, female, Maximum Input $\pm$ 5 VDC
Ethernet	RJ45 connector for Ethernet 10/100-BaseT (Available with Option 411 Ethernet)

### Display

Type	Resistive Touch Screen
Size	8.4 in, daylight viewable color LCD
Resolution	800 x 600

### Power

Field replaceable Battery	Li-Ion, 633-75, 7500 mAh 40 W on battery power only
DC Power	Universal 110/220 V AC/DC Adapter 55 W running off AC/DC adaptor while charging battery
Life time charging cycles	> 300 (80 % of initial capacity)
Battery Operation	3.6 hours, typical
Battery Charging Limits	0 $^{\circ}$ C to +45 $^{\circ}$ C, Relative Humidity $\leq$ 80 %





## General Specifications (continued)

### Electromagnetic Compatibility

European Union	CE Mark, EMC Directive 89/336/EEC, 92/31/EEC, 93/68/EEC, and Low Voltage Directive 73/23/EEC, 93/68/EEC
Australia and New Zealand	C-tick N274
Interference	EN 61326-1
Emissions	EN 55011
Immunity	EN 61000-4-2/-4-3/-4-4/-4-5/-4-6/-4-11

### Environmental (MS202xB/3xB)

#### MIL-PRF-28800F, Class 2

Temperature, operating (°C) (3.8.2.1 & 4.5.5.14)	Passed, -10 °C to 55 °C, Humidity 85 %, non-condensing
Temperature, not operating (°C) (3.8.2.2 & 4.5.5.1)	Passed, -40 °C to 71 °C
Relative humidity (3.8.2.3 & 4.5.5.1)	Passed
Altitude, not operating (3.8.3 & 4.5.5.2)	Passed, 4600 m (Qualified by similarity — tested on a similar product)
Altitude, operating (3.8.3 & 4.5.5.2)	Passed, 4600 m (Qualified by similarity — tested on a similar product)
Vibration limits (3.8.4.1 & 4.5.5.3.1)	Passed
Shock, functional (3.8.5.1 & 4.5.5.4.1)	Passed
Transit Drop (3.8.5.2 & 4.5.5.4.2)	Passed
Bench handling (3.8.5.3 & 4.5.5.4.3)	Passed
Shock, high impact (3.8.5.4 & 4.5.5.4.4)	Not Required (Not defined in standard; must be invoked and defined by purchase description)
Salt exposure structural parts (3.8.8.2 & 4.5.6.2.2)	Not Required (Not required for Class 2 equipment)

#### Explosive Atmosphere

MIL-PRF-28800F, Section 4.5.6.3	Passed
MIL-STD-810G, Method 511.5, Procedure 1	Passed

### Size and Weight

Dimensions	Height: 199 mm (7.8 in) Width: 273 mm (10.7 in) Depth: 91 mm (3.6 in)
Weight, Including Battery	3.5 kg (7.6 lb)

### Safety

Safety Class	EN 61010-1 Class 1
Product Safety	IEC 60950-1 when used with Company-supplied Power Supply













### Warranty

Duration	Standard three-year warranty (battery one-year warranty)
----------	--

## Instrument Options

## VNA Master Handheld Vector Network Analyzer + Spectrum Analyzer

Includes standard three-year warranty and Certificate of Calibration and Conformance.

	MS2024B	MS2025B	MS2034B	MS2035B	Description
	500 kHz to 4 GHz	500 kHz to 6 GHz	500 kHz to 4 GHz 9 kHz to 4 GHz	500 kHz to 6 GHz 9 kHz to 6 GHz	Vector Network Analyzer Spectrum Analyzer
	MS2024B-0010	MS2025B-0010	MS2034B-0010	MS2035B-0010	Built-in Bias-Tee, +12 V to +32 V variable
	MS2024B-0015	MS2025B-0015	MS2034B-0015	MS2035B-0015	Vector Voltmeter
	MS2024B-0019	MS2025B-0019	MS2034B-0019	MS2035B-0019	High Accuracy Power Meter (requires external USB sensor, sold separately)
			MS2034B-0025	MS2035B-0025	Interference Analyzer <sup>a</sup>
			MS2034B-0027	MS2035B-0027	Channel Scanner <sup>a</sup>
	MS2024B-0031	MS2025B-0031	MS2034B-0031	MS2035B-0031	GPS Receiver <sup>b</sup>
	MS2024B-0098	MS2025B-0098	MS2034B-0098	MS2035B-0098	Z-540 Calibration
	MS2024B-0099	MS2025B-0099	MS2034B-0099	MS2035B-0099	Premium Calibration
	MS2024B-0411	MS2025B-0411	MS2034B-0411	MS2035B-0411	Ethernet Connectivity
			MS2034B-0431	MS2035B-0431	Coverage Mapping <sup>c</sup>
			MS2034B-0509	MS2035B-0509	AM/FM/PM Demodulation Analyzer

a. GPS Option 31 recommended.

b. Requires external GPS antenna (sold separately).

c. Requires GPS Option 31.

## Standard Accessories (Included with instrument)



Part Number	Description
10920-00060	Handheld Instruments Documentation Disc
2300-577	Anritsu Software Tool Box for Handheld RF Instruments Disc
2000-1654-R	Soft Carrying Case
2000-1691-R	Stylus with Coiled Tether
2000-1797-R	Screen Protector Film (x2, one factory installed, one spare)
633-75	Rechargeable Li-Ion Battery, 7500 mAh
40-187-R	AC-DC Adapter
806-141-R	Automotive Power Adapter, 12 VDC, 60 W
3-2000-1498	USB A/5-pin mini-B Cable, 10 ft/305 cm
-	Certificate of Calibration and Conformance

## Optional Accessories

## Miscellaneous Accessories



Part Number	Description
MA2700A	Handheld Interference Hunter (For full specifications, refer to the MA2700A Technical Data Sheet 11410-00692)
2000-1371-R	Ethernet Cable, 2.1 m (7 ft)
3-806-152	Cat 5e Crossover Patch Cable, 2.1 m (7 ft)
633-75	Rechargeable Li-Ion Battery, 7500 mAh
2000-1374	External Dual Charger for Li-Ion Batteries
2000-1689	EMI Near Field Probe Kit
2000-1797-R	Screen Protector Film
2300-517	Phase Noise Measurement Software (requires Ethernet Option 0411)

## Backpack and Transit Case



Part Number	Description
67135	Anritsu Backpack (For Handheld Instrument and PC)
760-243-R	Large Transit Case with Wheels and Handle

**GPS Antennas (active)**



**Part Number Description**

2000-1652-R	Magnet Mount, SMA(m), 3 VDC to 5 VDC with 1 ft cable
2000-1528-R	Magnet Mount, SMA(m), 3 VDC to 5 VDC with 4.6 m (15 ft) extension cable
2000-1760-R	Mini GPS Antenna, SMA(m), 25 dB gain, 2.5 VDC to 3.7 VDC

**Power Sensors** (For complete ordering information see the respective datasheets of each sensor)



**Model Number Description**

PSN50	High Accuracy RF Power Sensor, 50 MHz to 6 GHz, +20 dBm
MA24105A	Inline Power Sensor, 350 MHz to 4 GHz, +3 dBm to +51.76 dBm
MA24106A	High Accuracy RF Power Sensor, 50 MHz to 6 GHz, +23 dBm
MA24108A	Microwave USB Power Sensor, 10 MHz to 8 GHz, +20 dBm
MA24118A	Microwave USB Power Sensor, 10 MHz to 18 GHz, +20 dBm
MA24126A	Microwave USB Power Sensor, 10 MHz to 26 GHz, +20 dBm
MA25100A	RF Power Indicator

**Full Temperature N-Type Coaxial Calibration Kits** -10 °C to +55 °C (see individual data sheets on [www.anritsu.com](http://www.anritsu.com))



**Part Number Description**

OSLN50A-8	High Performance Type N(m), DC to 8 GHz, 50 Ω
OSLNF50A-8	High Performance Type N(f), DC to 8 GHz, 50 Ω
TOSLN50A-8	High Performance with Through, Type N(m), DC to 8 GHz, 50 Ω
TOSLNF50A-8	High Performance with Through, Type N(f), DC to 8 GHz, 50 Ω

**Full Temperature K-Type Coaxial Calibration Kits**

K-type connectors are compatible with 3.5 mm and SMA connectors. -10 °C to +55 °C



**Part Number Description**

TOSLK50A-20	High Performance with Through, Type K(m), DC to 20 GHz, 50 Ω
TOSLKF50A-20	High Performance with Through, Type K(f), DC to 20 GHz, 50 Ω

**Coaxial Calibration Components, Other 50 Ω, 75 Ω**



**Part Number Description**

OSLN50-1	Type N(m) Integrated Open/Short/Load, 42 dB, 6 GHz
OSLNF50-1	Type N(f) Integrated Open/Short/Load, 42 dB, 6 GHz
22N50	Precision N(m) Short/Open, 18 GHz
22NF50	Precision N(f) Short/Open, 18 GHz
28N50-2	Precision Termination, DC to 18 GHz, 50 Ω, N(m)
28NF50-2	Precision Termination, DC to 18 GHz, 50 Ω, N(f)
SM/PL-1	Precision N(m) Load, 42 dB, 6 GHz
SM/PLNF-1	Precision N(f) Load, 42 dB, 6 GHz
2000-1618-R	Open/Short/Load, 7/16 DIN(m), DC to 6.0 GHz 50 Ω
2000-1619-R	Open/Short/Load, 7/16 DIN(f), DC to 6.0 GHz 50 Ω
12N50-75B	Matching Pad, DC to 3 GHz, 50 Ω to 75 Ω
22N75	Open/Short, N(m), DC to 3 GHz, 75 Ω
22NF75	Open/Short, N(f), DC to 3 GHz, 75 Ω
26N75A	Precision Termination, N(m), DC to 3 GHz, 75 Ω
26NF75A	Precision Termination, N(f), DC to 3 GHz, 75 Ω
1091-55-R	Open, TNC(f), DC to 18 GHz
1091-53-R	Open, TNC(m), DC to 18 GHz
1091-56-R	Short, TNC(f), DC to 18 GHz
1091-54-R	Short, TNC(m), DC to 18 GHz
1015-54-R	Termination, TNC(f), DC to 18 GHz
1015-55-R	Termination, TNC(m), DC to 18 GHz

## Phase-Stable Test Port Cables, Armored



Part Number	Description
15NNF50-1.5C	1.5 m, DC to 6 GHz, N(m) to N(f), 50 Ω
15NN50-1.5C	1.5 m, DC to 6 GHz, N(m) to N(m), 50 Ω
15NDF50-1.5C	1.5 m, DC to 6 GHz, N(m) to 7/16 DIN(f), 50 Ω
15ND50-1.5C	1.5 m, DC to 6 GHz, N(m) to 7/16 DIN(m), 50 Ω
15NNF50-3.0C	3.0 m, DC to 6 GHz, N(m) to N(f), 50 Ω
15NN50-3.0C	3.0 m, DC to 6 GHz, N(m) to N(m), 50 Ω

## Directional Antennas



Part Number	Description
2000-1777-R	0.09 MHz to 20 MHz, N(f), -160 dBi to -42 dBi, Log Periodic
2000-1778-R	20 MHz to 200 MHz, N(f), -40 dBi to -3 dBi, Log Periodic
2000-1779-R	200 MHz to 500 MHz, N(f), -13 dBi to -4 dBi, Log Periodic
2000-1812-R	450 MHz to 512 MHz, N(f), 7.1 dBi, Yagi
2000-1659-R	698 MHz to 787 MHz, N(f), 10.1 dBi, Yagi
2000-1411-R	822 MHz to 900 MHz, N(f), 12.1 dBi, Yagi
2000-1412-R	885 MHz to 975 MHz, N(f), 12.3 dBi, Yagi
2000-1660-R	1425 MHz to 1535 MHz, N(f), 14.3 dBi, Yagi
2000-1413-R	1710 MHz to 1880 MHz, N(f), 12.3 dBi, Yagi
2000-1414-R	1850 MHz to 1990 MHz, N(f), 11.4 dBi, Yagi
2000-1416-R	1920 MHz to 2170 MHz, N(f), 14.1 dBi, Yagi
2000-1415-R	2400 MHz to 2500 MHz, N(f), 14.1 dBi, Yagi
2000-1726-R	2500 MHz to 2700 MHz, N(f), 14.1 dBi, Yagi
2000-1715-R	698 MHz to 2500 MHz, N(f), 6 dBi to 7 dBi (typical), Bi-Blade
2000-1747-R	300 MHz to 5000 MHz, N(f), 4 dBi to 7 dBi (typical), Log Periodic
2000-1519-R	500 MHz to 3000 MHz, Log Periodic
2000-1617	600 MHz to 21000 MHz, N(f), 5-8 dBi to 12 GHz, 0-6 dBi to 21 GHz, Log Periodic
2000-1748-R	1000 MHz to 18000 MHz, N(f), 6 dBi to 7 dBi (typical), Log Periodic

## Portable Antennas



Part Number	Description
2000-1200-R	806 MHz to 866 MHz, SMA(m), 50 Ω
2000-1473-R	870 MHz to 960 MHz, SMA(m), 50 Ω
2000-1035-R	896 MHz to 941 MHz, SMA (m), 50 Ω (1/4 wave)
2000-1030-R	1710 MHz to 1880 MHz, SMA(m), 50 Ω (1/2 wave)
2000-1474-R	1710 MHz to 1880 MHz with knuckle elbow (1/2 wave)
2000-1031-R	1850 MHz to 1990 MHz, SMA(m), 50 Ω (1/2 wave)
2000-1475-R	1920 MHz to 1980 MHz and 2110 MHz to 2170 MHz, SMA(m), 50 Ω
2000-1032-R	2400 MHz to 2500 MHz, SMA(m), 50 Ω (1/2 wave)
2000-1361-R	2400 MHz to 2500 MHz, 5000 MHz to 6000 MHz, SMA(m), 50 Ω
2000-1636-R	Antenna Kit (Consists of: 2000-1030-R, 2000-1031-R, 2000-1032-R, 2000-1200-R, 2000-1035-R, 2000-1361-R, and carrying pouch)
2000-1616	20 MHz to 21000 MHz, N(f), 50 Ω
2000-1487	Telescopic Whip Antenna

## Bandpass Filters



Part Number	Description
1030-114-R	806 MHz to 869 MHz, N(m) to SMA(f), 50 Ω
1030-109-R	824 MHz to 849 MHz, N(m) to SMA (f), 50 Ω
1030-110-R	880 MHz to 915 MHz, N(m) to SMA (f), 50 Ω
1030-105-R	890 MHz to 915 MHz Band, 0.41 dB loss, N(m) to SMA(f), 50 Ω
1030-111-R	1850 MHz to 1910 MHz, N(m) to SMA (f), 50 Ω
1030-106-R	1710 MHz to 1790 MHz Band, 0.34 dB loss, N(m) to SMA(f), 50 Ω
1030-107-R	1910 MHz to 1990 MHz Band, 0.41 dB loss, N(m) to SMA(f), 50 Ω
1030-112-R	2400 MHz to 2484 MHz, N(m) to SMA (f), 50 Ω
1030-155-R	2500 MHz to 2700 MHz, N(m) to N(f), 50 Ω

**Adapters****Part Number Description**

1091-26-R	SMA(m) to N(m), DC to 18 GHz, 50 Ω
1091-27-R	SMA(f) to N(m), DC to 18 GHz, 50 Ω
1091-80-R	SMA(m) to N(f), DC to 18 GHz, 50 Ω
1091-81-R	SMA(f) to N(f), DC to 18 GHz, 50 Ω
1091-172	BNC(f) to N(m), DC to 1.3 GHz, 50 Ω
510-90-R	7/16 DIN(f) to N(m), DC to 7.5 GHz, 50 Ω
510-91-R	7/16 DIN(f) to N(f), DC to 7.5 GHz, 50 Ω
510-92-R	7/16 DIN(m) to N(m), DC to 7.5 GHz, 50 Ω
510-93-R	7/16 DIN(m) to N(f), DC to 7.5 GHz, 50 Ω
510-96-R	7/16 DIN(m) to 7/16 DIN (m), DC to 7.5 GHz, 50 Ω
510-97-R	7/16 DIN(f) to 7/16 DIN (f), DC to 7.5 GHz, 50 Ω
513-62	Adapter, DC to 18 GHz, TNC(f) to N(f), 50 Ω
1091-315	Adapter, DC to 18 GHz, TNC(m) to N(f), 50 Ω
1091-324	Adapter, DC to 18 GHz, TNC(f) to N(m), 50 Ω
1091-325	Adapter, DC to 18 GHz, TNC(m) to N(m), 50 Ω
1091-317	Adapter, DC to 18 GHz, TNC(m) to SMA(f), 50 Ω
1091-318	Adapter, DC to 18 GHz, TNC(m) to SMA(m), 50 Ω
1091-323	Adapter, DC to 18 GHz, TNC(m) to TNC(f), 50 Ω
1091-326	Adapter, DC to 18 GHz, TNC(m) to TNC(m), 50 Ω
510-102-R	N(m) to N(m), DC to 11 GHz, 50 Ω, 90 degrees right angle

**Precision Adapters****Part Number Description**

34NN50A	Precision Adapter, N(m) to N(m), DC to 18 GHz, 50 Ω
34NFN50	Precision Adapter, N(f) to N(f), DC to 18 GHz, 50 Ω

**Attenuators****Part Number Description**

3-1010-122	20 dB, 5 W, DC to 12.4 GHz, N(m) to N(f)
42N50-20	20 dB, 5 W, DC to 18 GHz, N(m) to N(f)
42N50A-30	30 dB, 50 W, DC to 18 GHz, N(m) to N(f)
3-1010-123	30 dB, 50 W, DC to 8.5 GHz, N(m) to N(f)
1010-127-R	30 dB, 150 W, DC to 3 GHz, N(m) to N(f)
3-1010-124	40 dB, 100 W, DC to 8.5 GHz, N(f) to N(m), Uni-directional
1010-121	40 dB, 100 W, DC to 18 GHz, N(f) to N(m), Uni-directional
1010-128-R	40 dB, 150 W, DC to 3 GHz, N(m) to N(f)

## Related Literature, Application Notes, Manuals

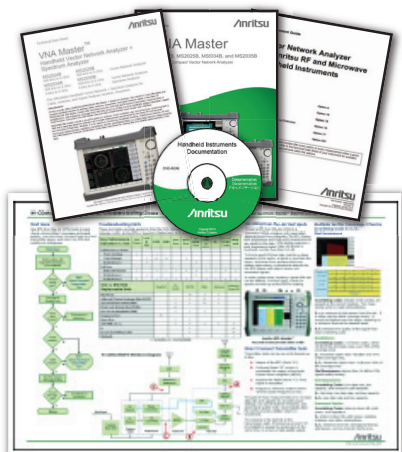

Part Number	Description
10580-00244	Spectrum Analyzer Measurement Guide
10580-00240	Power Meter Measurement Guide
10580-00289	VNA Measurement Guide
10580-00301	VNA Master User Guide
10580-00302	VNA Master Programming Manual
10580-00303	VNA Master Maintenance Manual
11410-00206	Time Domain for Vector Network Analyzers
11410-00214	Reflectometer Measurements – Revisited
11410-00270	What is Your Measurement Accuracy?
11410-00373	Distance-to-Fault
11410-00387	Primer on Vector Network Analysis
11410-00414	High Accuracy Power Meter, PSN50
11410-00424	USB Power Sensor MA24106A
11410-00504	Microwave USB Power Sensor MA241x8A
11410-00531	Practical Tips on Making “Vector Voltmeter (VVM)” Phase Measurements using VNA Master (Option 15)
11410-00545	VNA Master + Spectrum Analyzer Brochure
11410-00549	VNA Master + Spectrum Analyzer Technical Data Sheet
11410-00472	Measuring Interference
11410-00476	Essentials of Vector Network Analysis
11410-00565	Troubleshoot Wire Cable Assemblies with Frequency-Domain Reflectometry
11410-00700	Evaluation of RF Network Testing
11410-00601	Effectively Testing 700 MHz Public Safety LTE Broadband and P25 Narrowband Networks
11410-00608	Finding Radio Frequency Interferers
11410-00818	High Q Notch Filter Measurements

---

**Notes**



The Master Users Group is an organization dedicated to providing training, technical support, networking opportunities and links to Master product development teams. As a member you will receive the Insite Quarterly Newsletter with user stories, measurement tips, new product news and more.

Visit us to register today: [www.anritsu.com/mug](http://www.anritsu.com/mug)



Customers in the United States can receive a quote to purchase a product or order accessories by visiting our online ordering site: [www.ShopAnritsu.com](http://www.ShopAnritsu.com)

## Training at Anritsu

Anritsu has designed courses to help you stay up to date with technologies important to your job. For available training courses visit: [www.anritsu.com/training](http://www.anritsu.com/training)



### • United States

#### **Anritsu Company**

1155 East Collins Blvd, Suite 100,  
Richardson, TX 75081, U.S.A.  
Toll Free: 1-800-267-4878  
Phone: +1-972-644-1777  
Fax: +1-972-671-1877

### • Canada

#### **Anritsu Electronics Ltd.**

700 Silver Seven Road, Suite 120,  
Kanata, Ontario K2V 1C3, Canada  
Phone: +1-613-591-2003  
Fax: +1-613-591-1006

### • Brazil

#### **Anritsu Eletrônica Ltda.**

Praça Amadeu Amaral, 27 - 1 Andar  
01327-010 Bela Vista, São Paulo, Brazil  
Phone: +55-11-3283-2511  
Fax: +55-11-3288-6940

### • Mexico

#### **Anritsu Company, S.A. de C.V.**

Av. Ejército Nacional No. 579 Piso 9, Col. Granada  
11520 México, D.F., México  
Phone: +52-55-1101-2370  
Fax: +52-55-5254-3147

### • United Kingdom

#### **Anritsu EMEA Ltd.**

200 Capability Green  
Luton, Bedfordshire LU1 3LU  
United Kingdom  
Phone: +44-1582-433280  
Fax: +44-1582-731303

### • France

#### **Anritsu S.A.**

12 Avenue du Québec,  
Bâtiment Iris 1-Silic 612,  
91140 Villebon-sur-Yvette, France  
Phone: +33-1-60-92-15-50  
Fax: +33-1-64-46-10-65

### • Germany

#### **Anritsu GmbH**

Nemetschek Haus, Konrad-Zuse-Platz 1  
81829 München, Germany  
Phone: +49-89-442308-0  
Fax: +49-89-442308-55

### • Italy

#### **Anritsu S.r.l.**

Via Elio Vittorini 129, 00144 Roma, Italy  
Phone: +39-06-509-9711  
Fax: +39-06-502-2425

### • Sweden

#### **Anritsu AB**

Kistagången 20B, 164 40 KISTA, Sweden  
Phone: +46-8-534-707-00  
Fax: +46-8-534-707-30

### • Finland

#### **Anritsu AB**

Teknobulevardi 3-5  
FI-01530 Vantaa, Finland  
Phone: +358-20-741-8100  
Fax: +358-20-741-8111

### • Denmark

#### **Anritsu A/S**

Kay Fiskers Plads 9, 2300 Copenhagen S, Denmark  
Phone: +45-7211-2200  
Fax: +45-7211-2210

### • Russia

#### **Anritsu EMEA Ltd.**

##### **Representation Office in Russia**

Tverskaya str. 16/2, bld. 1, 7th floor  
Russia, 125009, Moscow  
Phone: +7-495-363-1694  
Fax: +7-495-935-8962

### • United Arab Emirates

#### **Anritsu EMEA Ltd.**

##### **Dubai Liaison Office**

P O Box 500413 - Dubai Internet City  
Al Thuraya Building, Tower 1, Suite 701, 7th Floor  
Dubai, United Arab Emirates  
Phone: +971-4-3670352  
Fax: +971-4-3688460

### • Singapore

#### **Anritsu Pte. Ltd.**

11 Chang Charn Road, #04-01, Shriro House  
Singapore 159640  
Phone: +65-6282-2400  
Fax: +65-6282-2533

### • India

#### **Anritsu India Private Limited**

2nd & 3rd Floor, #837/1, Binnamangla 1st Stage,  
Indiranagar, 100ft Road, Bangalore - 560038, India  
Phone: +91-80-4058-1300  
Fax: +91-80-4058-1301

### • P.R. China (Shanghai)

#### **Anritsu (China) Co., Ltd.**

27th Floor, Tower A,  
New Caohejing International Business Center  
No. 391 Gui Ping Road Shanghai, Xu Hui Di District,  
Shanghai 200233, P.R. China  
Phone: +86-21-6237-0898  
Fax: +86-21-6237-0899

### • P.R. China (Hong Kong)

#### **Anritsu Company Ltd.**

Unit 1006-7, 10/F., Greenfield Tower,  
Concordia Plaza,  
No. 1 Science Museum Road, Tsim Sha Tsui East,  
Kowloon, Hong Kong, P. R. China  
Phone: +852-2301-4980  
Fax: +852-2301-3545

### • Japan

#### **Anritsu Corporation**

8-5, Tamura-cho, Atsugi-shi,  
Kanagawa, 243-0016 Japan  
Phone: +81-46-296-1221  
Fax: +81-46-296-1238

### • Korea

#### **Anritsu Corporation, Ltd.**

5FL, 235 Pangyoyeok-ro, Bundang-gu,  
Seongnam-si,  
Gyeonggi-do, 463-400 Korea  
Phone: +82-31-696-7750  
Fax: +82-31-696-7751

### • Australia

#### **Anritsu Pty Ltd.**

Unit 21/270 Ferntree Gully Road  
Notting Hill, Victoria, 3168, Australia  
Phone: +61-3-9558-8177  
Fax: +61-3-9558-8255

### • Taiwan

#### **Anritsu Company Inc.**

7F, No. 316, Sec. 1, Neihu Rd, Taipei 114, Taiwan  
Phone: +886-2-8751-1816  
Fax: +886-2-8751-1817

List Revision Date: 20140624



© Anritsu All trademarks are registered trademarks of their respective companies. Data subject to change without notice. For the most recent specifications visit: [www.anritsu.com](http://www.anritsu.com)  
Anritsu utilizes recycled paper and environmentally conscious inks and toner.

MS202xB/MS203xB VNA Master TDS  
Copyright October 2014 Anritsu Company, USA  
All Rights Reserved



11410-00549



L